



# Post Frame Building Fastening Solutions



# Design, Manufacture & Supply

**SFS is the building envelope specialist. We serve the construction industry with fastening solutions for low slope roofing, post-frame construction, metal building systems, commercial construction facades and curtain walls, subframe support systems, offsite and modular construction and mass timber construction.**

But we're not just a fastener company. We have designed and developed innovative installation tools that increase productivity and make installation more accurate and easier.

At SFS, our vertically integrated supply chain keeps the fastener production, coating and packaging of our products in our hands. This provides greater assurance that we will live up to our quality, delivery and service commitments.

Together with our expertise, we can help you find the right product and systems for your project.

---

## Table of Contents

<b>Woodgrip™ Metal Panel to Wood Fasteners</b>	7
<b>Long-life Metal Panel to Wood Fasteners</b>	7
<b>Stitch and Light Metal Connections</b>	8
<b>Metal to Wood Clip Fasteners</b>	9
<b>ConnexTite™ Structural Wood Screw</b>	10
<b>Accessories</b>	10

---

# Intense Color, Ultimate Performance

Our VistaCoat® premium system is a proprietary high-performance finish that is durable, provides exceptional UV and corrosion resistance and is environmentally friendly. This system is designed to endure rigorous fastener applications and provide the highest quality installed product.

SFS has the ability to color match to any panel color, but we've already made it easy by offering a broad pallet of standard colors that match the majority of OEM panels. Check out our online color selector tool – its easy to find the SFS color code to match many OEM panel colors.

If you are a panel manufacturer and want fasteners perfectly matched to your panels, just submit a color chip to us.

## SFS Standard VistaCoat® colors

The below chart is a representation of our standard VistaCoat® color offering. Color swatches are a representation only, and not to be used for exact matching.

### White

- 014 Bright White
- 001 White
- 348 Bone White
- 330 Warm White
- 818 Sierra White

### Brown

- 020 Tan
- 548 Ivory
- 248 Light Stone
- 415 Beige
- 109 Sand Beige
- 422 Taupe
- 230 Desert Brown
- 110 Brown
- 374 Dark Brown

### Green

- 385 Patina
- 052 Teal Green
- 660 Hemlock
- 232 Evergreen
- 732 Denali Green
- 228 Green
- 925 Classic Green
- 798 Hartford Green

### Red

- 102 Crimson Red
- 928 Terra Cotta
- 890 Red
- 691 Barn Red
- 074 Colonial Red
- 393 Burgundy

### Bronze

- 537 Medium Bronze
- 042 Burnished Slate
- 324 Dark Bronze

### Blue

- 432 Blue Teal
- 012 Blue
- 843 Regal Blue
- 421 Navy

### Black

- 023 Black
- 507 Matte Black

### Gray

- 850 Ash Gray
- 302 Pearl Gray
- 578 Old Town Gray
- 696 Pewter Gray
- 091 Zinc Gray
- 051 Charcoal Gray
- 416 Slate Gray

### Metallic

- 1160 Champagne Metallic
- 1161 Silver Metallic
- 1162 Zactique Metallic
- 1116 Copper Penny Metallic





# We're Committed to Service

**At SFS, positive customer experience is paramount. We are committed to fulfilling customer requirements by going above and beyond expectations. We blend proactive engineering and holistic add-on services to provide our customers end to end solutions.**

---

## Our services at a glance

### Engineering services

Our highly creative technical specialists provide a systematic approach. This includes multi-disciplined engineering services which ensure optimal performance of the building envelope.

### Services for facade framing systems

We are experts in design development, shop drawings and submittal calculations on complex building facades.

### Order and delivery services

Our reliable order processes and worldwide delivery network, ensure complete and on-time as ordered service.

### Job site services

Our professional network offers on-site product training.

### Tool repair program

We offer quick turn-around repair service of SFS productivity tools.

### eLogistics

Our automated logistics processes with track and trace features mean customers spend less time from order to delivery.



# Our Online Power Tools



**SFS connects you to the information you need with powerful, online tools. Easy to use, these tools take the guess work out of the equation. You can feel confident when you place an order that you will receive exactly what you need.**

## **NVELOPE budget calculator**

Quickly and easily estimates the square foot cost of NVELOPE thermally broken cladding support system materials needed for your project.

## **NVELOPE DesignRX**

Design a rainscreen bracket system dependent on factors such as local wind loads, height of the facade, substrate being fixed to, selected cladding material and the cladding zone. All NVELOPE cladding systems can be engineered to project specific requirements.

## **Fastener color selector**

Makes finding the perfect SFS color match to an OEM panel easy.

## **Panel clip product finder**

Provides all the SFS standing seam roof panel clips that work with your roll forming equipment and attachment method.

## **VistaVent® ridge ventilation product finder**

Identifies the SFS product which is cut to fit your panel profile.

## **VistaFoam® closure product finder**

Three easy ways to find closure cut to fit your panel profile.

# Require more information?

This brochure is just an overview of the many products and services SFS has to offer. You may find you need more information before you are ready to buy... and SFS has it available for you. Always feel free to contact us by phone or email. Or visit our website where you can easily find a vast array of information at your fingertips.

## Product data sheets

We have indepth product data sheets available on most products published on our website for easy viewing or download. These data sheets provide information on:

- Application
- Features and benefits
- Product specifications
- Engineering drawing
- Performance values
- Product selection
- Installation and application considerations

**SFS**

### #12-14 ZAC® Impax SD3 (5/16") Metal to Metal Fastener

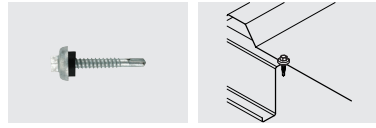

**Features and Benefits**

- Zinc alloy cast head that will never red rust
- Precision cold forged assuring superior strength and the fastest driving time performance
- Designed to have low driving and thread engagement torque and provide maximum clamping load
- Special long pilot length to accommodate rusted surfaces
- Assisted EPDM seating washer for a consistent weather tight seal
- Long life fastener limited warranty

**Application**  
Manufactured to light and medium gauge metal application.

**Product Selection**

Material No.	Fastener Length	Thread Length*	Description
794238	1"	Full	ZS24-#12
1024876	1-1/4"	Full	ZS24-#12
1025181	1-1/2"	Full	ZS24-#12
798548	2"	Full	ZS24-#12

\*Plain product bagged 250 pieces, unless otherwise noted.  
\*Note - Thread length measured from end of pilot length to end of the thread.

US: T 800 234 4533 | Canada: T 866 847 5400 | www.sfsintec.com

**SFS**

### #12-14 ZAC® Impax SD3 (5/16") Metal to Metal Fastener

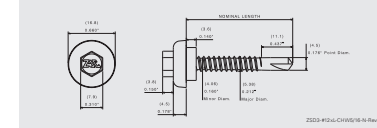

**Product Specifications**

Diameter: #12 (5.38 mm)  
 Threads Per Inch: 14  
 Head Style: 5/16" dia Zinc alloy capped HVH AF (7.9 mm)

Washer: EPDM seating washer  
 Drill Point: S23  
 Drill Capacity: 0.550"-0.210" (13.889 mm-5.334 mm)  
 Thread Major Dia: 0.212" (5.38 mm)  
 Thread Minor Dia: 0.162" (4.06 mm)

**Performance Data\*\***

Material Strength	2500 SF / 11025 N	Pull Out Strength Steel	ICC-pretreated 45 ksi	SFS testing 55 ksi
Steel	1950 SF / 8707 N	16 dia (13 mm)	493 SF / 2142 N	655 SF / 2928 N
Aluminum	82 SF / 367 N	16 dia (13 mm)	131 SF / 592 N	170 SF / 760 N
		12 dia (9 mm)	123 SF / 5492 N	153 SF / 6792 N

**ICC-pretreated 45 ksi**  
 28 dia (22 mm) 854 SF / 3792 N  
 24 dia (19 mm) 758 SF / 3407 N  
 22 dia (18 mm) 723 SF / 3234 N

\*\*SFS Testing Facility (SFS-IT) | SFS-AM0573 | P/N: 8576

**Installation and Application Considerations**  
 Tools: 5-2000 rpm screw gun equipped with depth sensing nose piece. Fastener length should provide for a minimum of 3/16" penetration of fully developed threads into metal substrate.

**Use of impact guns or hammer drills is not recommended.**

US: T 800 234 4533 | Canada: T 866 847 5400 | www.sfsintec.com

## Ready to buy?

We're here to assist you in your purchase decision and make it easy. Our SFS outside sales force and our inside customer service team are available to answer questions and make your journey a smooth one.

### United States







800 234 4533  
 T +1 610 376 5751  
 us.construction@sfsintec.biz  
 www.sfsintecusa.com

### Canada



866 847 5400  
 T +1 905 689 5401  
 ca.info@sfsintec.biz  
 www.sfsintec.ca

# Post Frame Building Fastening Solutions

## Woodgrip™ metal panel to wood fasteners



	Product	Diameter	Threads per inch	Head style/drive	Washer	Point	Lengths
	#9 Woodgrip	#9	15	1/4" HWH	Control seal	Sharp point	1" to 3"
	#10 Woodgrip HiLo	#10	15	1/4" HWH	Bond seal	Type 17 milled point	1" to 3"
	#12 Woodgrip XG	#12	8	1/4" HWH	Bond seal	Sharp point	1" to 2-1/2"
	#14 Type 17 A-MP	#14	10	5/16" HWH	Bond seal	Type 17 A-milled point	1" to 3"
	#10 Woodgrip HiLo LP Exterior sidewall	#10	15	1/2" pan head T25	Bond seal	Type 17 milled point	1" to 2"
	#10 Woodgrip HiLo LP Interior liner panel	#10	15	1/2" pan head T25	Bond seal	Sharp point	1" to 1-1/2"

## Long-life metal panel to wood fasteners

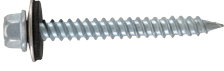

	Product	Diameter	Threads per inch	Head style/drive	Washer	Point	Lengths
	#10 WoodZAC® HiLo	#10	15	5/16" HWH Zinc alloy capped	Aluminum bond seal	Type 17 milled point	1" to 3"
	#12 WoodZAC® XG	#12	8	5/16" HWH Zinc alloy capped	EPDM sealer	Sharp point	1" to 2-1/2"
	1/4-14 ZAC® Type AB	1/4"	14	3/8" HH Zinc alloy capped	EPDM sealer	Type AB milled point	1" to 2-1/2"

# Post Frame Building Fastening Solutions

## Long-life metal panel to wood fasteners continued

	Product	Diameter	Threads per inch	Head style/drive	Washer	Point	Lengths
	#10 WoodMAC HiLo	#10	15	1/4" HWH stainless capped	EPDM sealer	Type 17 milled point	1" to 2-1/2"
	#9 Evergrip® 304SS Bi-Met HWH	#9	15	1/4" HWH	Stainless bond seal	Carbon steel sharp point	1" to 2-1/2"
	#9 Evergrip® 304SS Bi-Met T25	#9	15	3/8" pan head T25	Stainless bond seal	Carbon steel sharp point	1" to 3"
	#9 Aluminum Panel 304SS	#9	15	1/4" HWH	Aluminum bond seal	Sharp point	1" to 3"

## Stitch and light metal connections





	Product	Diameter	Threads per inch	Head style/drive	Washer	Point	Lengths
	#12 Woodgrip Lap	#12	14	1/4" HWH	Control seal	Sharp point	3/4"
	#12 Woodgrip Lap	#12	14	1/4" HWH	Bond seal	Sharp point	3/4"

	Product	Diameter	Body	Mandrel	US dimensions
	American Standard Blind Rivet	1/8"	Stainless	Stainless	43, 44, 46



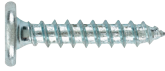
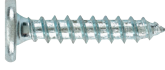

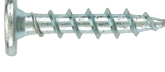
# Standing Seam Panel Fastening Solutions

## Metal to wood clip fasteners





	Product	Diameter	Threads per inch	Head style/drive	Point	Lengths
	#10 Type A Pancake	#10	12	Pancake #2 square	Type A	1" to 2"
	#10 Type A Pancake 304SS	#10	12	Pancake #2 square	Type A	1" to 2"
	#12 Type A Pancake	#12	11	Pancake #2 square	Type A	1"
	#12 XG Low Profile	#12	8	Wafer #2 square	Sharp point	1" to 2"
	#12 XG Pancake	#12	8	Pancake #2 square	Sharp point	1" to 2"
	#14 Dekfast	#14	13	Truss #3 Phillips	Reduced SD1	1-1/4" to 12"

# Post Frame Building Fastening Solutions

## ConnexTite™ structural wood screw

	Product	Diameter	Head style/drive	Washer	Point	Lengths
	Flange head	1/4"	Flange T25	-	ribbed	1-1/2" to 2-3/4"
	Flange head	5/16"	Flange T40	-	ribbed	2-3/4" to 5-1/2"
	Countersunk	5/16"	Flange T40	-	ribbed	2-3/4" to 4"

## Accessories

	Product	Description
	VistaVent® Ridge Ventilation	Panel fit and universal venting material. Many panel profiles available.
	VistaFoam® Closure Strips	Panel opening filler designed to close gaps in roof and sidewall applications. Available in most panel profiles.
	Hannoband® BG1	Self-expanding joint sealing tape for joints, seams and gaps.
	Butyl Tape	Side and end lap sealing of metal panels, roof vents and pipe flashing.
	Pipe Flashing	Round, square and retrofit configurations. Gray and black EPDM and red silicone. Many size options available.





SFS Group USA, Inc.  
Division Construction  
1045 Spring Street  
US-Wyomissing, PA 19610

800 234 4533  
T +1 610 376 5751  
F +1 610 376 8551  
us.construction@sfsintec.biz  
www.sfsintecusa.com

SFS – Canada  
40 Innovation Drive  
Dundas, ON L9H 7P3

866 847 5400  
T +1 905 689 5401  
ca.info@sfsintec.biz  
www.sfsintec.ca